

MİMARİ KATALOG
ARCHITECTURAL CATALOGUE

Alüminyum Kapı Pencere ve Giydirme Cephe Sistemleri
Aluminium Window Doors and Facade Systems



DÜZ ALDOOKS

MİMARİ KATALOG

ARCHITECTURAL CATALOGUE

Alüminyum Kapı Pencere ve Giydirme Cephe Sistemleri
Aluminium Window Doors and Facade Systems



Rescara Sistem Detayları
Rescara System Details

DÜZ ALDOKS

PROFİLLER

PROFILES

11

12

13

14

15

16

17

18

19

20

DÜZ ALDOKS SERİ

KOD#	AĞIRLIK kg/mt	L m	KOD#	AĞIRLIK kg/mt	L m
A000536	0,601	6	A000182	0,703	6
A000537	0,600	6	A000183	0,607	6
A000538	0,502	6	A000181	0,704	6

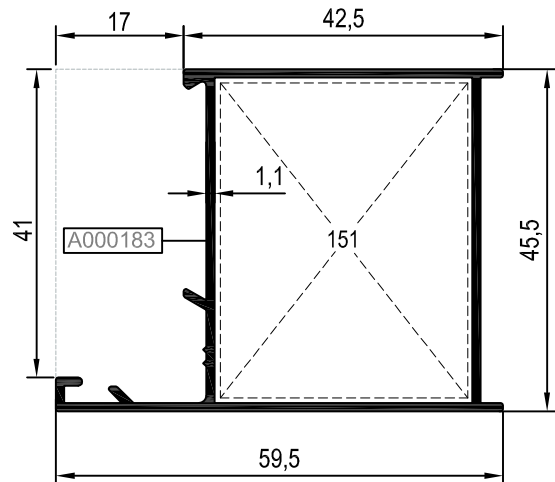
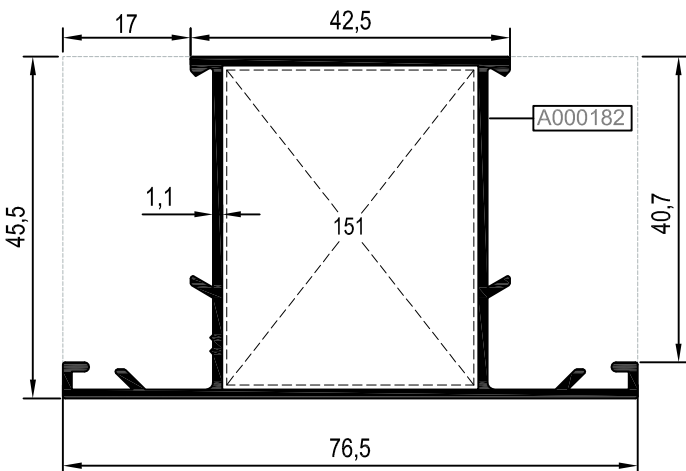
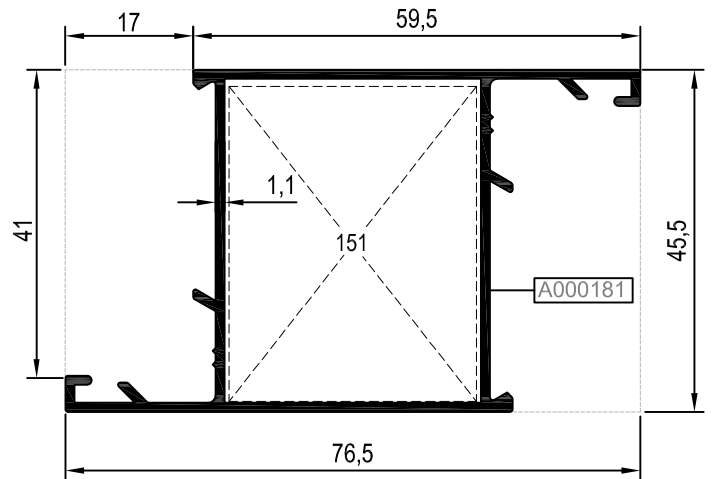
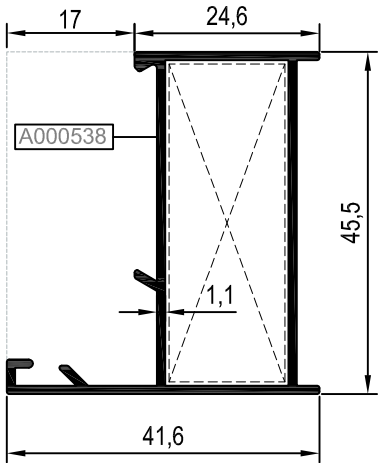
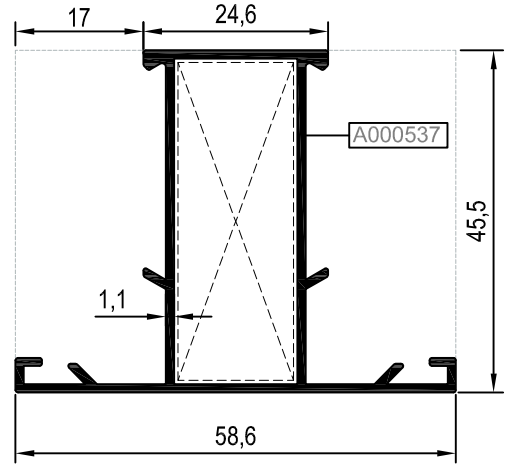
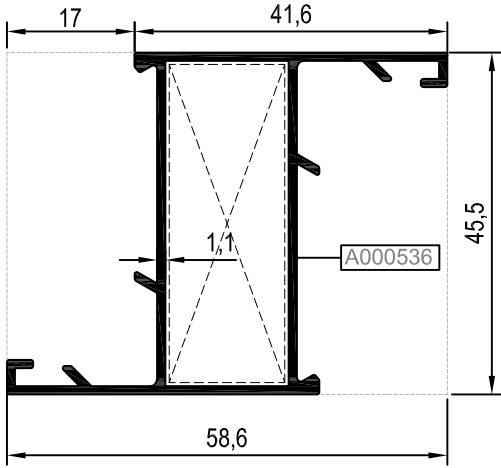

DÜZ ALDOKS SERİ

KOD#	AĞIRLIK kg/mt	← L m →
A003292	1,242	6
A003293	1,135	6
A003294	1,137	6

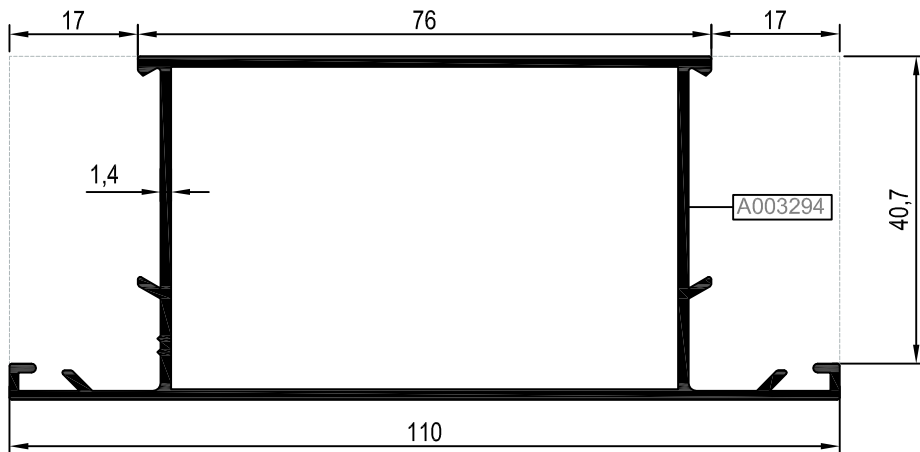
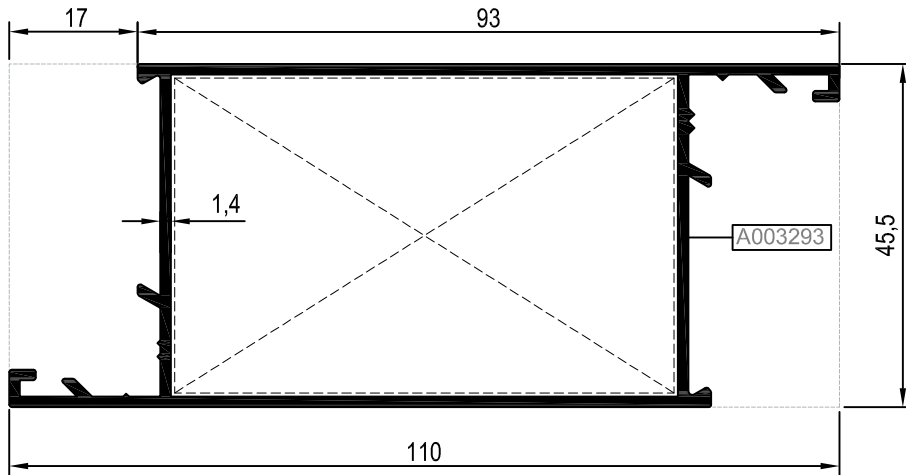
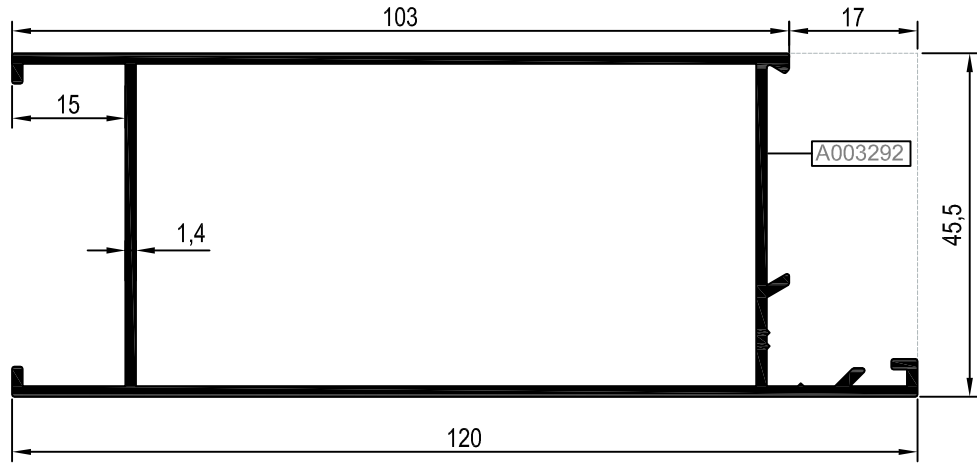

DÜZ ALDOKS SERİ

KOD#	AĞIRLIK kg/mt	← L m →
A000184	1,733	6
A000185	1,876	6

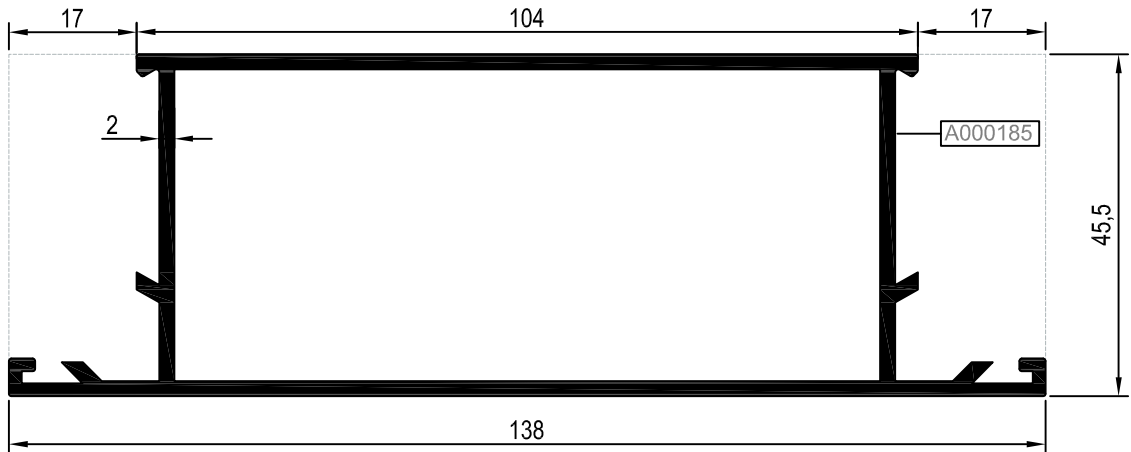
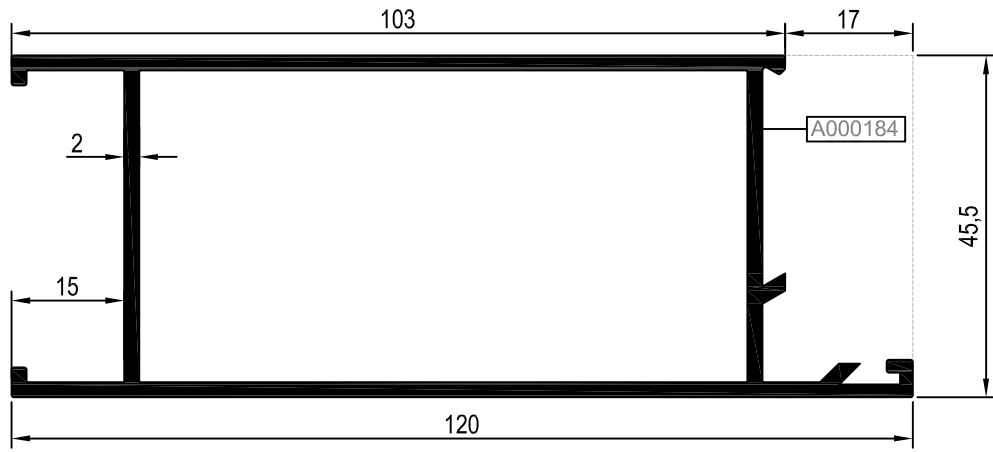

DÜZ ALDOKS SERİ

KOD#	AĞIRLIK kg/mt	L m
A000110	1,835	6
A004306	0,786	6
A011190	0,848	6

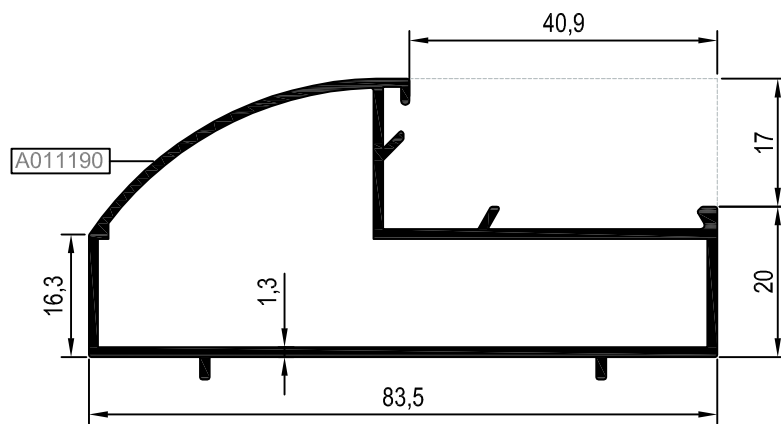
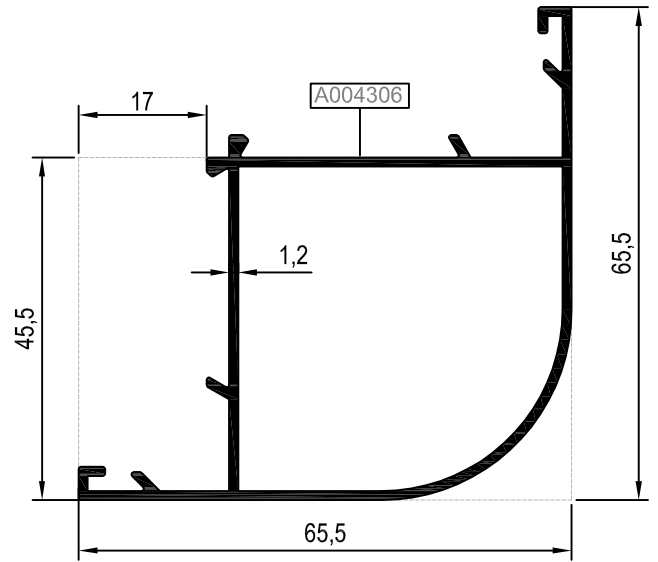
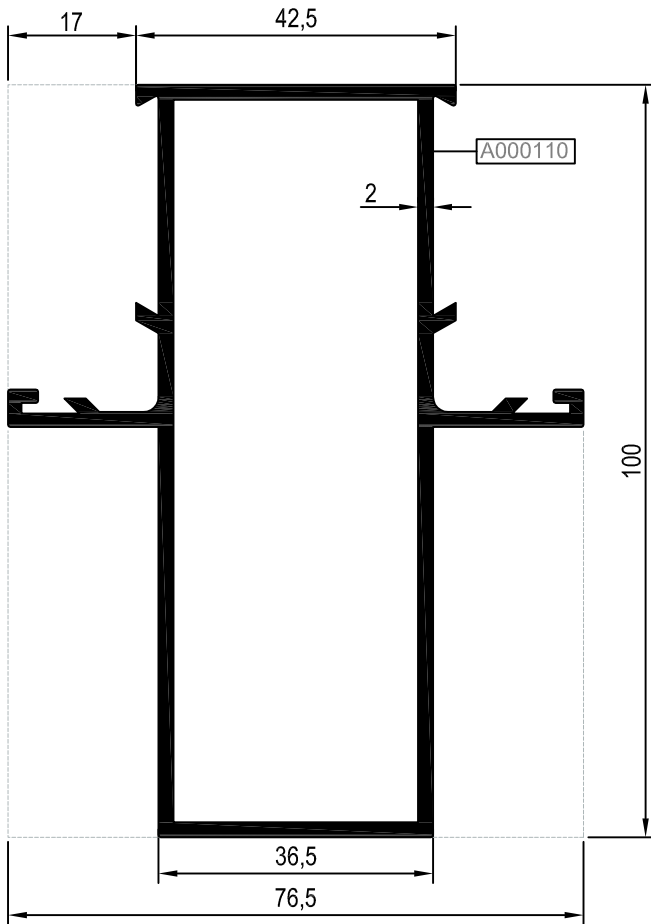

DÜZ ALDOKS SERİ

KOD #	AĞIRLIK kg/mt	L m
A000151	1,157	6
A000152	0,890	6
A000154	0,593	6
A002729	0,363	6

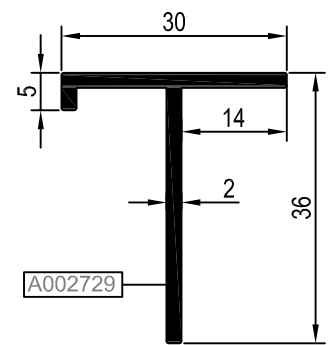
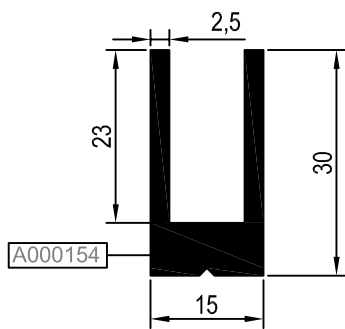
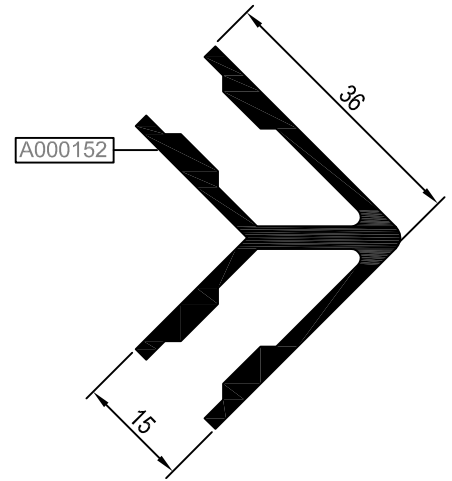
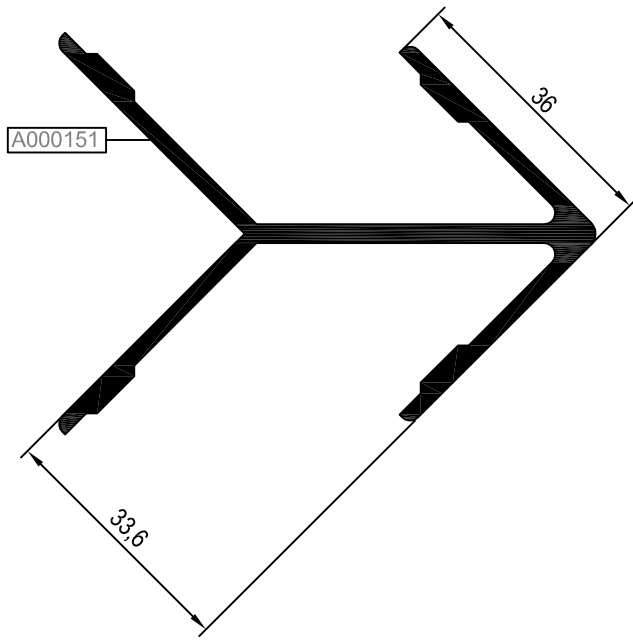

DÜZ ALDOKS SERİ

KOD #	AĞIRLIK kg/mt	L m	KOD #	AĞIRLIK kg/mt	L m
A000114	0,354	6	104	0,228	6
A000115	0,580	6	640	0,125	6
A000105	0,230	6	639	0,136	6

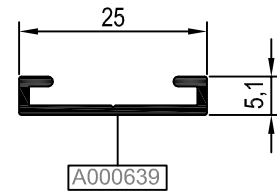
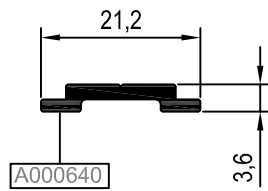
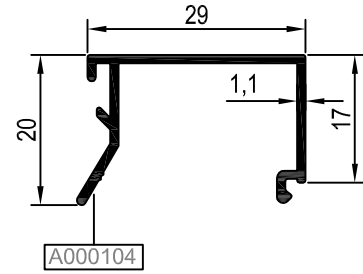
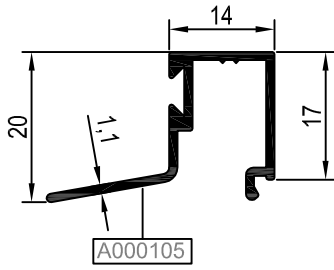
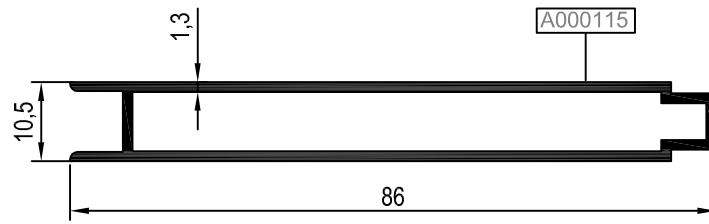

DÜZ ALDOKS SERİ

STOKTA BULUNAN SİSTEM PROFİLLERİNİN LİSTESİ (LIST OF SYSTEM PROFILES IN STOCK)

Nr	MIN. SİPARİŞ MİKTARI MIN. ORDER QUANTITY
A000104	75 kg
A000105	75 kg
A000151	75 kg
A000152	75 kg
A000158	75 kg
A000181	75 kg
A000182	75 kg
A000183	75 kg
A000536	75 kg
A000537	75 kg
A000538	75 kg
A003292	75 kg
A003293	75 kg
A003294	75 kg

* STOKTA BULUNMAYAN TÜM PROFİLLER İÇİN MİNİMUM SİPARİŞ MİKTARI 300 KG'DİR.
MINIMUM ORDER QUANTITY FOR ALL THE PROFILES THAT ARE NOT IN STOCK IS 300 KG.

MİMARİ KATALOG

ARCHITECTURAL CATALOGUE

Alüminyum Kapı Pencere ve Giydirme Cephe Sistemleri
Aluminium Window Doors and Facade Systems



Rescara Sistem Detayları
Rescara System Details

DÜZ ALDOKS

AKSESUARLAR

ACCESSORIES

11

12

13

14

15









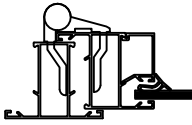
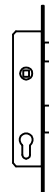
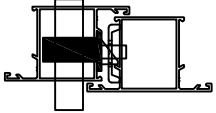

16

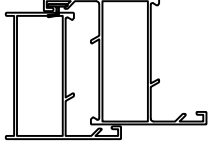
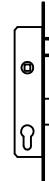
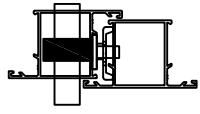
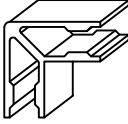
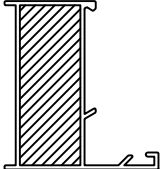
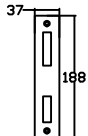
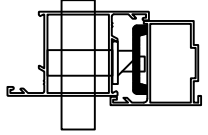
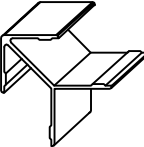
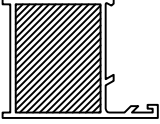
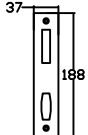
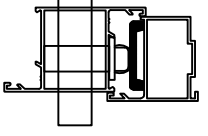

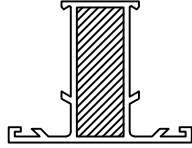
17

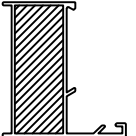
18

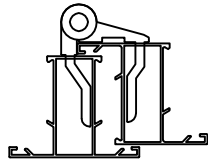
19

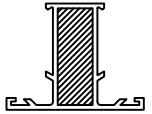
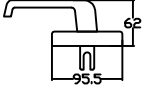
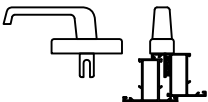
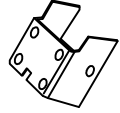
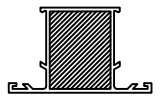
20

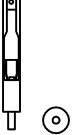
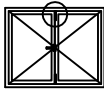
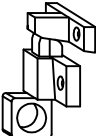
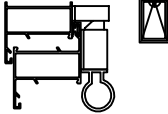
	01.17.13 CAM FİTİLİ GLAZING GASKET Malzeme / Material: EPDM Ağırlık / Weight: 17 gr/m Paket / Package: 880 m / 15 kg			18.01.04 DİLLİ KİLİT	
	01.18.26 KANAT FİTİLİ WING GASKET Malzeme / Material: EPDM Ağırlık / Weight: 0.025 kg/m Paket / Package: -			18.01.05 MAKARALI KİLİT	
	114 L 65 ALDOKS DAR KASA KANAT ORT.KAYIT KÖŞE TAKOZU Malzeme / Material: Alüminyum			18.02.15 DİLLİ KİLİT KARŞILIĞI	
	114 L 66 ALDOKS GENİŞ KASA KANAT ORT.KAYIT KÖŞE TAKOZU Malzeme / Material: Alüminyum			18.02.16 MAKARALI KİLİT KARŞILIĞI	
	114 J 14 ALDOKS DAR ORT.KAYIT BAĞLANTISI Malzeme / Material: Alüminyum			10.08.01 KÖŞE TAKOZU	
	15.01.10 DÜZ ALDOKS MENTEŞE Malzeme / Material: Alüminyum			10.08.02 ALDOKS DAR ORTA KAYIT BAĞLANTISI	
	07.05.21N EKSENEL KOL Malzeme / Material: Alüminyum			10.08.03 ALDOKS GENİŞ ORTA KAYIT BAĞLANTISI	

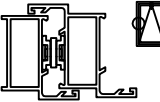
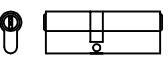
	18.03.01 ALDOKS SÜRGÜ				
	07.08.03 VASİSTAS MANDAL				
	07.07.06 VASİSTAS MAKAS				
	18.04.03 BAREL	